

NIMBUS n500

by GENAQ

User Guide

Atmospheric Water Generator
Remote Supply
500 liters/day



INDEX

| | |
|--|----|
| 1. General Information..... | 3 |
| 1.1. Introduction..... | 4 |
| 1.2. Specifications..... | 5 |
| 1.2.1. Circuits and Dimensions..... | 6 |
| 1.2.2. Safety Recommendations..... | 7 |
| 2. Start-up..... | 8 |
| 2.1. First Start-up..... | 9 |
| 2.1.1. UV Lamp Installation..... | 10 |
| 2.1.2. Start-Up..... | 12 |
| 2.1.3. Waste Management..... | 16 |
| 2.2. Quick Start Guide..... | 17 |
| 2.2.1. Operating Modes..... | 19 |
| 3. Maintenance..... | 22 |
| 3.1. Basic Maintenance..... | 23 |
| 3.1.1. External Cleaning..... | 23 |
| 3.1.2. Air Filters..... | 23 |
| 3.1.3. Hydraulic Circuit..... | 24 |
| 3.1.4. Preservation During Long Periods of Inactivity..... | 33 |
| 3.2. Professional Maintenance..... | 35 |
| 3.2.1. Refrigeration Circuit..... | 35 |
| 3.2.2. Air Circuit..... | 36 |
| 3.2.3. Chlorine Dosing Pump..... | 37 |
| 3.2.4. Control and Electrical Circuit..... | 37 |
| 4. Troubleshooting..... | 38 |
| 4.1. Troubleshooting..... | 39 |

1. General Information

1.1. Introduction

GENAQ Nimbus N500 is an Atmospheric Water Generator built in a **Remote Supply** construction, with a nominal generation capacity of 500 liters/day.

The Atmospheric Water Generator has been optimized to maximize the water production and minimize the energy cost per liter of produced water, as well as extend the system operating range to extreme temperature and extreme humidity conditions.

The generator operation diagram is the following:

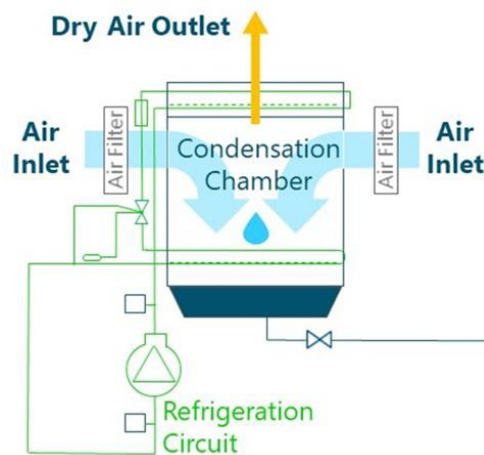

Figure 1: Atmospheric Water Generator working diagram

- The water generator takes laterally an atmospheric air flow that passes through a double air filter to the water precipitator.
- The water precipitator consists of a refrigeration cooler that cools the humid air to temperatures below its dew point, which produces water vapor condensation, present in the atmospheric air.
- When leaving the water precipitator, the air passes through an energy recovery section to precool the incoming air, so that the system energy consumption is considerably reduced.
- Finally, the air flow is carried outside, driven by radial fans.
- The hot and dry air flow is expelled outside by the generator's upper part. Due to the lower specific weight of the exhaust air, it rises naturally in the atmosphere, not interfering with the intake air.
- The condensed water remains in a tray and is pumped to the water filtration and storage system.

The refrigeration production for the precipitation of the water is obtained through a mechanical refrigerant compression cycle, equipped with alternative high efficiency compressors.

1.2. Specifications

Table 1: Technical Specifications

| | | |
|---------------------------------------|---|--|
| GENAQ Nimbus N500-4.3 | Version | 4.3 |
| | Nominal Generation, at 30°C and 80% RH ($\pm 10\%$) | 506 L/day |
| | Dimensions (Height x Width x Depth) | 1800 x 790 x 1180 mm |
| | Weight | 380 kg |
| | Color | White |
| | Manufactured in galvanized steel sheet structure with polyester paint of high resistance to corrosion | |
| Power Supply | Power Supply (Other Voltages Available) | 400V-III-50Hz |
| | Nominal Power | 5.1 kW |
| | Plug/Socket | 32A 5-pin Socket |
| Refrigerant Circuit | Refrigerant | R134A |
| | Evaporation coil built in copper tubes and aluminum fins | |
| | Condensation coil built in copper tubes and aluminum fins | |
| Air Circuit | Nominal Air Flow | 2000 m3/h |
| | Maximum Fan Operating Intensity | 2.2 A |
| | Air Pre-Filter | Anti-insect air prefilter |
| | Air Filter | F7 fine particles air filter |
| Hydraulic Circuit | Food grade low density lineal polyethylene tube | |
| | Nominal Water Flow | 7.6 L/min |
| | Pump Maximum Power | 96 W |
| | Internal Water Storage | 18.5 L |
| | Water Treatment | 20-micron Sediment Filter, 2 x 5-micron Sediment Filter, 2 x Activated Carbon Filter, 2 x Ultrafiltration Filter, Zeolite Filter, Mineralization Filter, and UV lamp |
| Control and Electrical Circuit | Control | DIXELL IPG208D-10021 and VTIPG |
| | Control Description | Electronic control unit with temperature display and ambient relative humidity. Remote monitoring and control (IoT, Internet of Things). Network analyzer with electric consumption meter and water meter |
| | Electrical and control panel with thermal, magnetothermal and differential protection | |
| | Safety, Alarms, Operating and Defrosting Cycles Control | |
| Safety Devices | Protection against refrigerant pressure abnormal levels for high and low pressure | |
| | Automatic resetting thermal protections in the compressor and motor fan | |
| | Protection fuses and electrical panel's general grounding | |
| Limits | Temperature Limits | 10°C to 45°C |
| | Relative Humidity Limits | 10% to 100% |
| | Storage Limit | -15°C to 70°C |

1.2.1. Circuits and Dimensions



| Number | Description |
|--------|--------------------------------|
| 1 | Air circuit |
| 2 | Electrical and control circuit |
| 3 | Hydraulic circuit |
| 4 | Refrigeration circuit |

Figure 2: Circuits

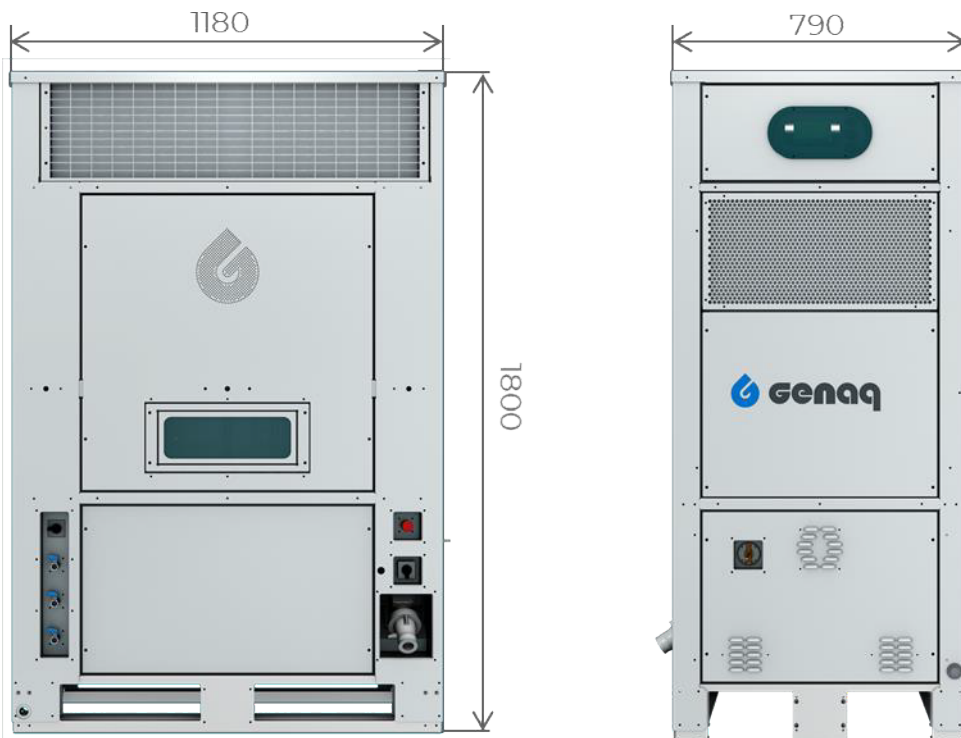

Figure 3: Dimensions

1.2.2. Safety Recommendations

To avoid all accidents risks during installation, commissioning, or maintenance, it is mandatory to follow the specific recommendations. The generator start-up, its repair and maintenance must be carried out by qualified personnel.

It is mandatory to follow the recommendations and instructions contained in maintenance manuals, labels, and specific instructions.



Before intervening in the generator, verify that the general generator power is cut to avoid electric shock

Refrigerant leaks can cause:

- Asphyxia, due to displacement of oxygen from the air, narcotic effect and cardiac arrhythmia, due to refrigerant's inhalation.



Always ensure good ventilation in the work area

- Eye irritations and burns from splashes or skin contact.



Wear safety glasses and gloves. Avoid all contact of the skin with the cooling fluid



Be careful with the cutting elements of the generator

In case of accident by coolant inhalation, act according to the following instructions:

- Move the victim to a place where he/she can breathe fresh air. The victim must remain lying down or in the sideways.
- Call emergency medical services if necessary.

In case of eye injuries due to refrigerant splash:

- Never rub your eyes. if contact lenses are used, they must be removed.
- The eyelids will be kept open and rinsed with plenty of water.
- Then, the victim will be transferred to a specialist doctor (ophthalmologist) or to an emergency service.

In case of skin burn by coolant contact:

- Rinse the affected parts with plenty of tap water and keep applying it while removing the clothes.
- The affected parts should never be covered with clothing, bandages, oil, etc.

2. Start-up

2.1. First Start-up

The generator location will condition its functioning. For optimum performance, follow these steps:

- Once received, check that there have been no damages in the generator or its components.
- Place the generator in an area with good air renewal and away from heat sources, clearing its intakes to facilitate the air aspiration and expulsion, and avoid air recirculation as much as possible.



To ensure good air circulation around the generator, air inlets and outlets must be clear.



Figure 4: Air intakes and outtakes

- Turn on the electrical power at least 8 hours before start-up. After few hours of operation, the main system parameters must be checked to ensure that the system is working correctly or if adjustments are necessary.
- This operation is particularly important for start-ups at low ambient temperatures.

For the first generator start-up (or after long inactivity periods), it is mandatory to perform a water tank cleaning and complete filling followed by a tank complete emptying through the Service.

After long periods of inactivity an hyperchlorination must be carried out, as indicated in the section ***Preservation in long periods of inactivity***.

If you have worked inside the generator, check that you do not leave any object inside, that there are no gas leaks and that the hydraulic connections have been carried out properly.

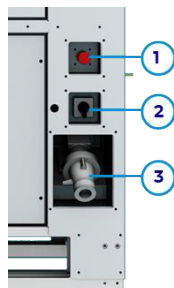

| Number | Description |
|--------|-----------------------|
| 1 | Emergency push button |
| 2 | Phases selector |
| 3 | Power supply |

Figure 5: Power Supply

2.1.1. UV Lamp Installation

The UV lamp is used to prevent the appearance of microorganisms in the hydraulic system. To do this, water is recirculated from the tank periodically.



The ultra-violet rays are harmful to skin and eyes.



The UV lamp will beep in the following cases:

- If the UV Lamp is broken
- If the UV Lamp connector is not properly connected

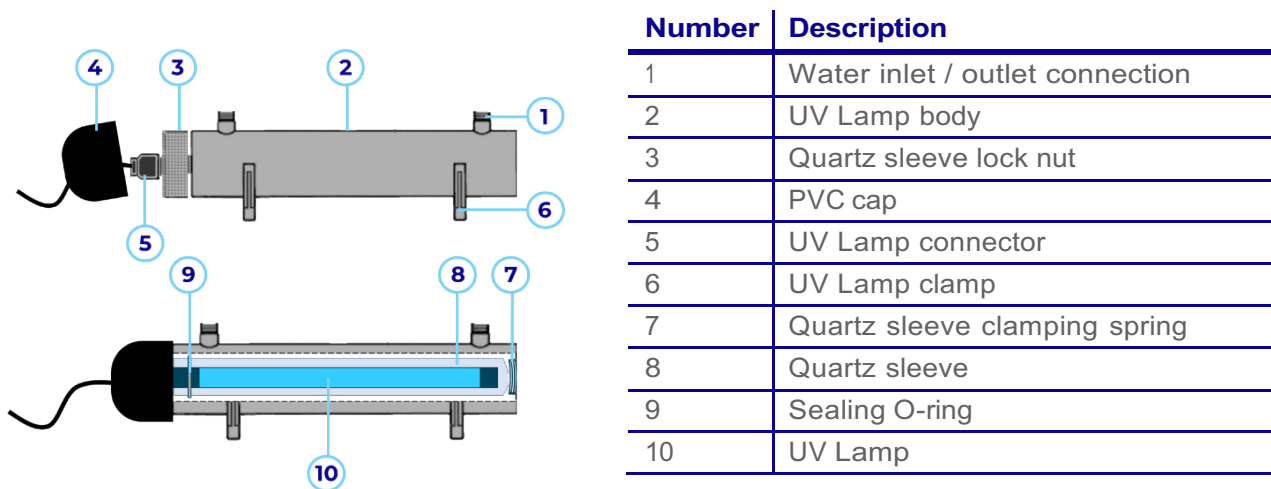

Figure 6: UV breakdown

You will receive your Generator with the UV lamp removed and packaged to avoid damage during transportation, it is necessary to install the Lamp **BEFORE STARTING THE GENERATOR**, make sure you have all the components before starting the assembly.

The assembly instructions are shown in the following sequence:

- Access to the hydraulic circuit.

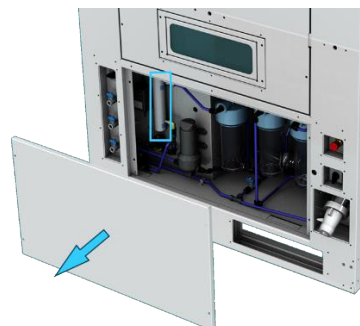

Figure 7: UV lamp access

- Extract the UV Lamp body (2) from the holder and unscrew the Quartz sleeve lock nut (3).

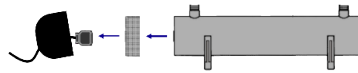

Figure 8: UV Lamp body breakdown

* Depending on the model, hydraulic connections are done with quick connectors or with screwed connectors. In the latter case, auxiliary tools may be necessary (like a crosshead screwdriver).

Make sure that the sealing O-ring (9) is installed in the quartz sleeve. Introduce the quartz sleeve (8) into the UV Lamp body (2). Insert the quartz sleeve keeping the tube completely straight to avoid damage the sleeve, this component is especially fragile.

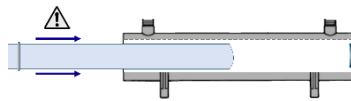

Figure 9: Quartz sleeve installation

- Screw the lock nut (3) to the UV Lamp body (2).



Figure 10: UV lamp lock nut

- Connect the UV Lamp (10) to the connector (5) and insert the lamp into the quartz sleeve (8). The Lamp must be inserted completely straight without damage the quartz tube.

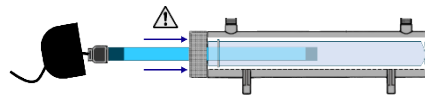

Figure 11: UV lamp installation

- Once all components are properly connected, insert the PVC cap (4) and install the UV lamp into the holder.

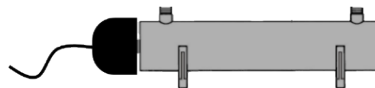

Figure 12: UV lamp

In case the UV lamp stops working, there will be a beep indicating it. In that case, the lamp would need to be replaced.

2.1.2. Start-Up

Once the UV lamp is installed, proceed to turn on the generator by turning the general switch selector to the ON position, it is necessary to follow these instructions before leaving the generator running:

- Check no active alarms.
- Check the phases are correctly connected:



| Number | Description |
|--------|--|
| 1 | Alarm: Phases sequence wrong. Proceed to phases selection |

Figure 13: Phases Sequence Alarm

If the light is on, turn the phase selector or change the position of the cables in the socket.

- Once verified, turn on the generator by pressing the T8 key on the screen, the generator turns on when the fan icon and the compressors show their status (% power).

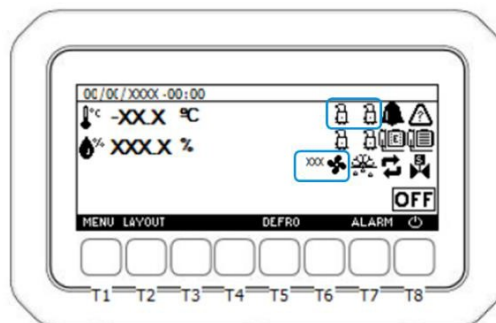

Figure 14: Display



Make sure do not leave any register open before Turn On the generator.

- For the first generator start-up (or after long inactivity periods), it is mandatory to clean the water tank, complete filling followed by a tank complete emptying.

2.1.2.1. External Tank Installation

If the generator will be used with an external tank with recirculation, follow the instructions:

- Connect the external-tank pipes:
 - Connect a pipe from **Inlet from Tank**, to the tank outlet.
 - Connect a pipe from **Outlet to Tank**, to the tank inlet.

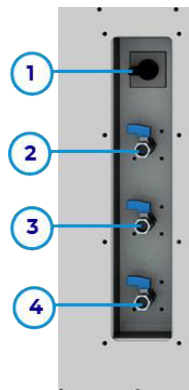

| Number | Description |
|--------|-----------------|
| 1 | Service switch |
| 2 | Service valve |
| 3 | Outlet to tank |
| 4 | Inlet from tank |

Figure 15: External tank connections

- Connect the level buoys as follows:
 - Upper-level buoy:
 - Introduce the level buoy into the external tank.
 - Regulate the high-level float switch as shown the images.

Make sure the level buoy does not rub into the top of the tank. Once the level is regulated, please affix the float with the safety ring.

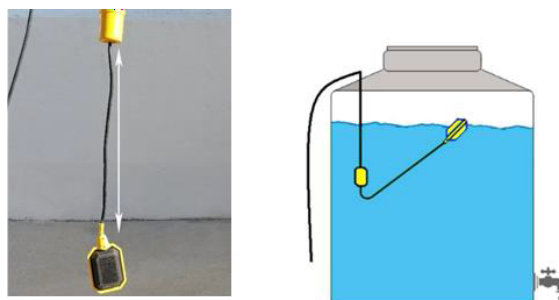

Figure 16: Upper buoy installation

- Lower-level buoy:
 - Introduce the level buoy into the external tank.
 - Regulate the Lower-level float switch as shown the images.

Make sure the level buoy does not rub with the bottom of the tank. Make sure the level float is higher than the level of the external tank tap.

Once the level is regulated, please affix the float with the safety ring.

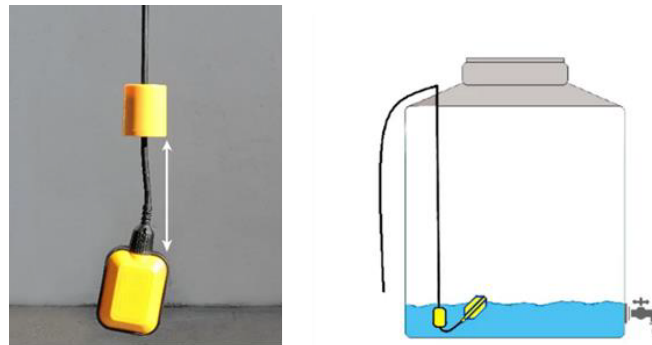
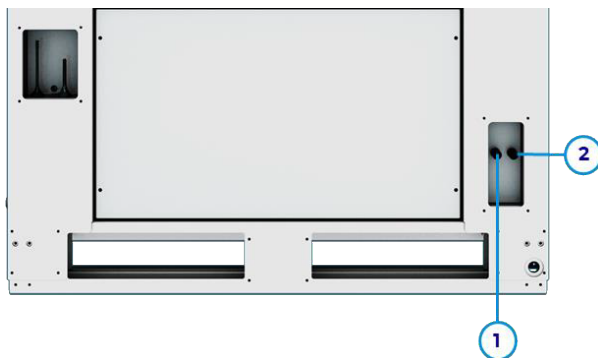

Figure 17: Lower buoy installation

- Connect the upper-level and lower-level buoys as indicated:



| Number | Description |
|--------|------------------|
| 1 | Upper level buoy |
| 2 | Lower level buoy |

Figure 18: Buoys connection

2.1.2.2. External Tank Selection Recommendations

This section aims to give recommendations that will facilitate the selection, installation and use of an external water tank feeds by an Atmospheric Water Generator. These indications **do not exclude the obligation to comply with the drinking water quality regulations** applicable in the place of use of the Generator.

- External Water Tank Material
 1. The water tank material must be suitable for drinking water (it is recommendable that it has a food grade certificate or similar).
 2. The valves and pipes must be built with materials that do not introduce into the water any substance or microorganism that alters its potability.
 3. The rest of the materials used for the external tank installation or for fixing it with another element must have food certified to ensure their compatibility with water for human consumption (for example, food grade silicone).

- External Water Tank Conditions

1. The tank must be sized according to daily use. You can also consider the followings indications:
 - a. If the water is treated with chlorine, it must be renewed at least once a week. You cannot mix chlorinated water with unchlorinated water; this eliminates the disinfection efficiency of chlorine.
 - b. The water cannot remain in the tank for more than 48 hours if not treated with chlorine.

For both cases, the water **cannot remain stagnant** so it must have a recirculation system towards an ultraviolet lamp. The recirculation system must ensure that the tank fully recirculates every 4 hours.

2. The tank piping must be insulated, the joints must be periodically cleaned and checked for leaks or corrosion caused by lack of insulation.
3. The tank must be kept sealed to prevent contamination.
4. The interior of the tank must be accessible to allow cleaning, inspection, etc.
5. The tank must have a purge system for its total emptying after maintenance tasks.

- External Water Tank Location

1. The storage water must remain at a temperature below 20°C to avoid the appearance of microorganisms.
2. The tank should not be exposed to sunlight for a long time. This wears down the material in the reservoir and can alter the quality of the water.
3. Do not install the tank in places with high humidity, this can cause condensation in the pipe.
4. Install the tank as close to the generator as possible to minimize the amount of standing water in the pipeline.
5. It is advisable to place the generator on a smooth surface, if possible, with an elevation from the ground.

- Water Quality

1. To ensure the quality of the water in the external tank, it may be necessary to install an additional filtration system sized according to the dimensions of the external tank.
2. If the use of the water stored in the external tank is for human or animal consumption:
 - a. Depending on the dimensions of the external tank, it may be necessary to carry out periodic analyzes to ensure that the water quality parameters comply with the regulations for drinking water.
 - b. In case of not complying with any of the parameters regulated by the regulations, the **water in the tank will be discarded and cannot be**

consumed until the alteration source of this parameter/parameters has been eliminated.

3. After any maintenance task it is necessary to sanitize the circuit. Do not use solvents, degreasers or products that are harmful to people.

2.1.3. **Waste Management**

After the generator installation, recycle the packaging and the pallet respecting the environment.

When replacing the generator or any of its components, respect the environment, using an authorized company to remove and recycle, in accordance with the current legislation.

2.2. Quick Start Guide

GENAQ Nimbus N500 can be managed entirely from the Control Panel on the front panel. The display has the followings functions and features:

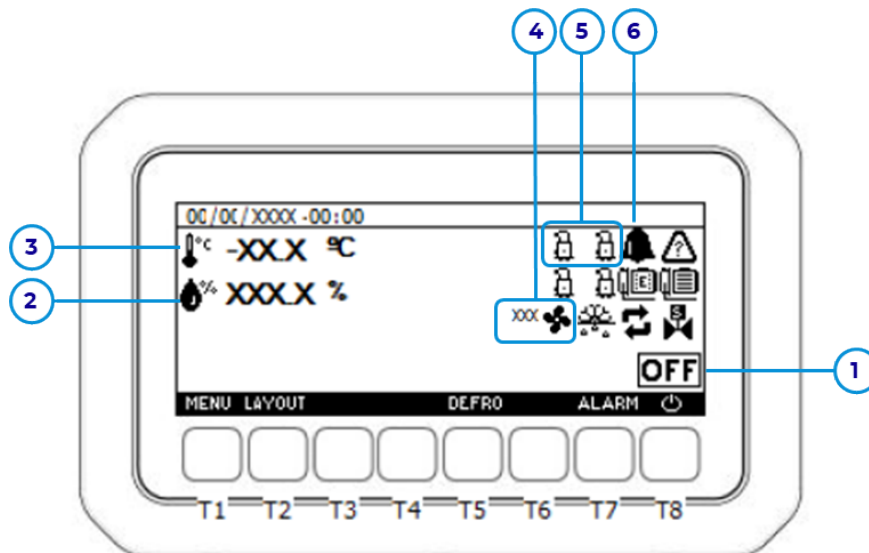

| Number | Description |
|--------|-------------------------|
| 1 | Generator ON/OFF |
| 2 | Inlet Relative Humidity |
| 3 | Inlet Temperature |
| 4 | Fan ON |
| 5 | Compressor ON |
| 6 | Alarm signal |

Figure 19: Display

Basic Functions of Control Command









Using the buttons on the control you can perform the following actions:

Table 2: Control Panel Actions

| Key | Screen | Action |
|-----|--------|---|
| T1 | MENU | Access to the main menu screen from where you can access the various submenus |
| T2 | LAYOUT | Synoptic access to a computer (LAYOUT) to display computer operation |
| T5 | DEFRO | Pressing for more than 3 seconds the button will force a manual defrost |
| T7 | ALARM | Access to interrupt section to display active alarms or reset them |
| T8 | I / O | Press for 5 seconds to turn the generator ON or OFF. |

The symbols displayed on the screen have the following meaning:

Table 3: Display Symbols

| | |
|---|---|
|  | The number to the right indicates how the compressor works: active, anti-short circuit, % active compressor capacity... The upper symbols correspond with circuit 1 and the lower symbols with circuit 2 |
|  | The generator is doing a Defrost |
|  | The fans are active: The number on the right indicates the % of the speed at which the fan is rotating |
|  | Alarm indicator. The generator has activated one or more alarms, for more information go to the interrupt section (T7 button) |
|  | It is activated hydraulic pump to evacuate the water collected in the tray. |
|  | It is activated hydraulic pump to evacuate the water collected in the external tank. |
|  | The generator being cooled, the liquid solenoid valve is active |
|  | Water recirculation is activated |
|  | There is a warning: For more information you need access to subsection warning on the main menu. |

Submenus Selection

The selection of the Sub selections is done at the screen MENU (T1)

Table 4: Submenus Symbols











| | |
|---|--|
|  | Parameters menu: Access to the config the generator |
|  | Input / output menu: Information of input and output values |
|  | Setpoint menu: Access to the setpoint submenu |
|  | Service menu: It permits access to the config and maintenance |
|  | Data register: It permits access to the USB menu and save the alarms data |
|  | Parameters list management: Menu access to load parameters or save the current configuration |
|  | Languages: Select display language |
|  | Warning: menu access to seeing the generator warnings |
|  | VEE Driver: Status the drivers of the electronics valves |
|  | Adjust date / time: Adjust the internal control date and time |

Table 5: Submenus Actions

| Key | Screen | Action |
|-----|--------|----------------------------|
| T1 | EXIT | Access to the main screen |
| T2 | ◀ | Previous item |
| T3 | ▶ | Next item |
| T4 | SET | Access to selected submenu |

2.2.1. Operating Modes

2.2.1.1. Without external tank and manual service

- The generator will store water only in the internal tank.
- Once full, the generator stops.
- Lower level in the internal tank must be active.
- The generator manages the water service.
- Water is served from the internal tank through the “**SERVICE**” Switch and the “**SERVICE**” valve.
- To select this mode, following these steps:
 - Make sure the following valves are positioned as follows (see diagram in **Basic Maintenance**, hydraulic circuit section):
 - “**Inlet from Tank**” Valve: **Closed**.
 - “**Outlet to Tank**” Valve: **Closed**.
 - Once all valves are adjusted, through the main screen, follow this sequence:
 - Configuration menu access: Press MENU > Parameters  > A1.- Unit configuration.
 - Configure the “Pump control mode” with the option ***W/o tank manual***.
- For a quick first start up and first filter cleaning, it is advisable using at least 20 liters water to fill the condensation tray and let it flow until the water runs clear to eliminate activated carbon particles that may contain the new filters.
- For long periods of inactivity (more than 1 week), please, check section “**Preservation During Long Periods of Inactivity**”.

2.2.1.2. Serving Water with “w/o tank manual” Mode

- Low buoy level is needed in Internal tank.
- Open the “**SERVICE**” valve.
- Set the Service Switch to position 1 to serve.
- Set the Service Switch to position 0 to stop the service.
- Close the “**SERVICE**” valve.

2.2.1.3. With External Tank

- Prior to selecting this mode, please, make sure the pipes and the level buoys are properly connected (see “**External Tank Installation**” section).
- The generator will store water in an external tank **automatically**.
- Once the internal tank is full, the generator will automatically empty the internal tank by pouring the water through the “**Outlet to Tank**” valve.
- Once the External tank is full, the generator stops.
- The generator manages the recirculation and the water service.
- Lower level in the external tank must be active.
- Water is served from the external tank through the “**SERVICE**” valve and the “**SERVICE**” switch.
- This mode is intended for filling an external tank with recirculation.
- To select this mode, following these steps:
 - Make sure the following valves are positioned as follows (see diagram in **Basic Maintenance**, hydraulic circuit section):
 - Inlet from Tank Valve: **Open**.
 - Outlet to Tank Valve: **Open**.
 - Once all valves are adjusted, through the main screen, follow this sequence:
 - Configuration menu access: Press MENU > Parameters  > A1.- Unit configuration.
 - Configure the “Pump control mode” with **W/ external tank**.
- For a quick first start up and first filter cleaning, it is advisable using at least 20 liters water to fill the condensation tray and let it flow until the water runs clear to eliminate activated carbon particles that may contain the new filters.
- For long periods of inactivity (more than 1 week), please, check section “**Preservation During Long Periods of Inactivity**”.

2.2.1.4. Serving Water with “W/ external tank” mode

- Low buoy level is needed in External tank.
- Open the “**SERVICE**” valve.
- Set the Service Switch to the position 1 to serve.
- Set the Service Switch to the position 0 to stop the service.
- Close the “**SERVICE**” valve.

2.2.1.5. Without external tank and automatic extraction

- **The water cannot be stored and drinkable without an additional water treatment.**
- Prior to selecting this mode, please, connect the pipe from “**SERVICE**” to the external tank inlet.
- The generator will store water in the internal storage and, once full, will **automatically** empty it by pouring the water through the “**SERVICE**” valve.
- The generation never stops.
- To select this mode, following these steps:
 - Make sure the following valves are positioned as follows (see diagram in **Basic Maintenance**, hydraulic circuit section):
 - Inlet from Tank Valve: **Closed**.
 - Outlet to Tank Valve: **Open**.
 - **Service: Closed**.
 - Once all valves are adjusted, through the main screen, follow this sequence:
 - Configuration menu access: Press MENU > Parameters  > A1.- Unit configuration.
 - Configure the “Pump control mode” with the option **W/o tank auto**.
- For a quick first start up and first filter cleaning, it is advisable to use at least 20 liters water to fill the condensation tray and let it flow until the water runs clear to eliminate activated carbon particles that can contain a new filter.

2.2.1.6. Serving Water with “W/o tank auto” mode

The service of the water will be automatically when the upper-level buoy in the internal storage is active.

3. Maintenance

3.1. Basic Maintenance

GENAQ Nimbus N500 atmospheric water generator requires:

- **Basic Maintenance**, to be carried out by the user.
- **Professional Maintenance**, to be carried out by a refrigeration professional qualified for this generator.



Any repair, replacement or intervention in the generator by unauthorized personnel will lead to the cancellation of the Warranty.



During maintenance, turn off the power and wear protective gloves to avoid possible cuts.

It is important to follow the Maintenance recommendations with the **frequency** indicated in this Manual

The Basic Maintenance tasks are described below:

3.1.1. External Cleaning

To keep your generator free of dust and dirt, wipe the housing surface with a damp cloth. Do not use detergents or solvents.

Frequency: Depending on the location.

3.1.2. Air Filters

By the generator use, dust and dirt will be deposited on the air filters, hindering the air flow. This requires a periodic filter cleaning and replacement.



It is mandatory disconnect the generator from the power grid before any maintenance task.

3.1.2.1. Air Inlet Filter

- Unscrew and remove the filters as indicated in the following sequence.



Figure 20: Air inlet access

- Remove the filters and replace them. If spare parts are not available, please contact support@auqvian.se.

Frequency: Once a year, in dusty environments, the replacement frequency may increase.

3.1.2.2. Air Outlet Filter

- Unscrew and remove the filters as indicated in the following sequence.



Figure 21: Air outlet access

- Remove the filters and replace them. If spare parts are not available, please contact support@auqvian.se.

Frequency: Replacement in case of deterioration.

3.1.3. Hydraulic Circuit

The hydraulic circuit is composed of several elements that require supervision, cleaning and replacement maintenance:



It is mandatory to disconnect the generator from the power grid before any maintenance task.

3.1.3.1. Diagram

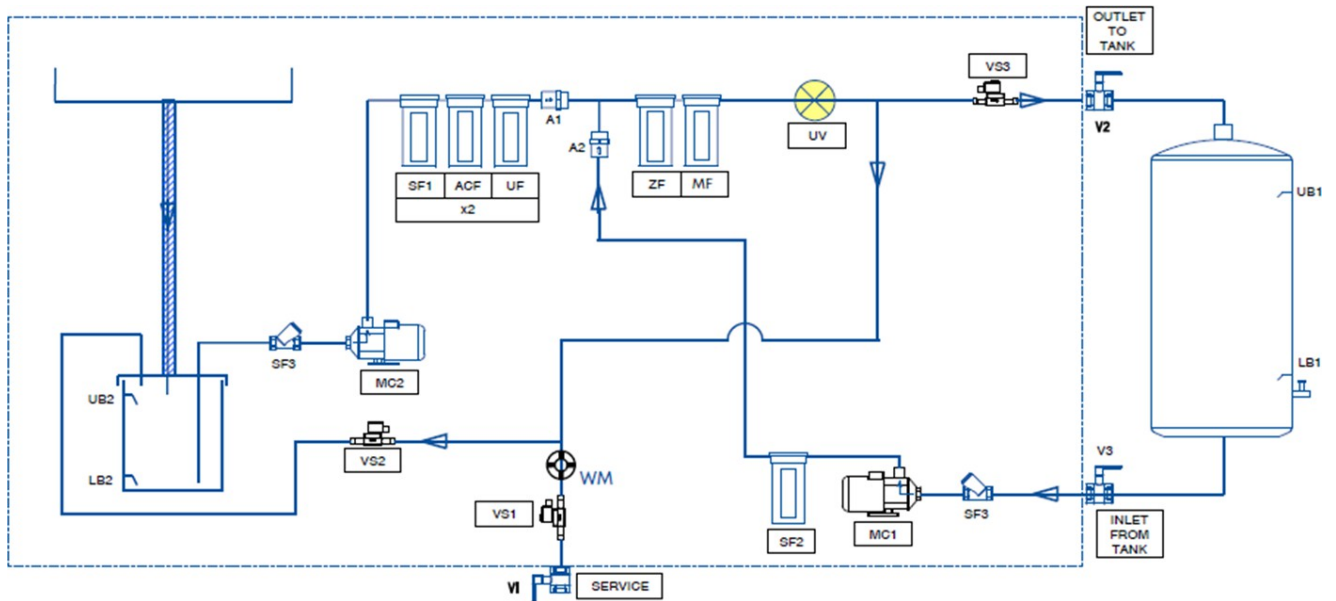

| Code | Description |
|-----------------|--------------------------------------|
| VS1, VS2... | Solenoid valve VS1, VS2... |
| MC1 | External tank water pump |
| MC2 | Internal tank water pump |
| UV | UV Lamp |
| MF | Mineralization filter |
| ZF | Zeolite filter |
| UF | Ultrafiltration filter |
| ACF | Activated Carbon Filter |
| SF | Sediment filter |
| A1, A2... | Retention valve |
| WM | Water meter |
| SERVICE | Service valve |
| OUTLET TO TANK | Water outlet valve to external tank |
| INLET FROM TANK | Water inlet valve from external tank |

Figure 22: Hydraulic circuit

3.1.3.2. Hydraulic components

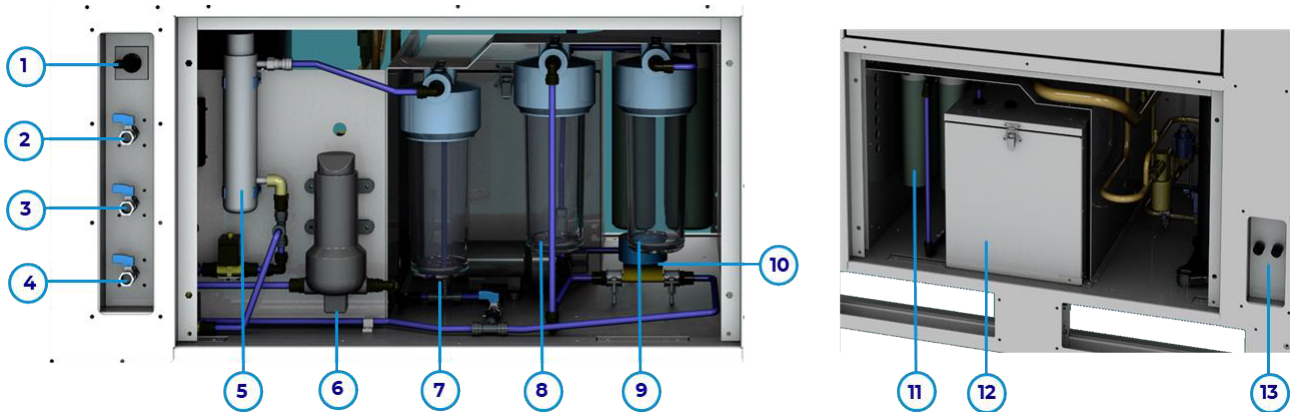

| Number | Description |
|--------|---|
| 1 | Service Switch |
| 2 | Service valve |
| 3 | Outlet to Tank, water outlet to external tank |
| 4 | Inlet from Tank, water inlet from external tank |
| 5 | UV Lamp |
| 6 | Water pump |
| 7 | Sediment filter |
| 8 | Mineralization filter |
| 9 | Zeolite filter |
| 10 | Water meter |
| 11 | Filtration group |
| 12 | Internal tank |
| 13 | External tank level buoys |

Figure 23: Hydraulic circuit components

3.1.3.3. Leakage Check

Periodically check the absence of leaks in the hydraulic circuit and after any cleaning or replacement operation. To disconnect the pipe, press the ring and pulling the pipe in opposite direction (it is recommendable help with a 10 open-end wrench). To ensure the connection, introduce the pipe completely into the quick connection.

In case of doubts, please contact support@auqvian.se.

Frequency: In each maintenance operation.

3.1.3.4. Condensation Tray

The condensation tray cleaning requires removing the access panel as shown below:

- Turn off the generator by pressing the ON/OFF key at the display and disconnect it from the power supply.
- Access to the condensation tray by removing the front panel.



Figure 24: Condensation tray access panel

- With the panel removed, proceed to clean the condensation tray. Clean the tray with products that do not damage the stainless steel of the tray and that are not harmful to health, such as bleach dissolved with water. Do not use solvents, degreasers or products that are harmful to health.
- After cleaning the condensation tray, it is necessary to clean the water tank, since the cleaning product goes from the drain of the tray to the tank.
- Once the condensation tray panel is cleaned, screw the front panel.
- Turn On the generator.

Frequency: Depending on the air quality of the place, its frequency is 1 month

3.1.3.5. Water Filters

The water filters are used to trap particles that have passed through the main air filters, to avoid microbiological and chemical contamination risk, to avoid any smell or flavor in the water, and to enrich it with minerals.

To replace the filters, please, follow these steps:

- Turn off the generator and disconnect it from the power supply.
- Access into the hydraulic circuit location.

3.1.3.5.a. Sediment Filter (SF2)

- Unscrew the filter head counterclockwise and extract the wound propylene filter.

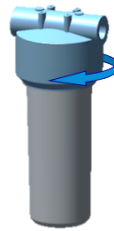
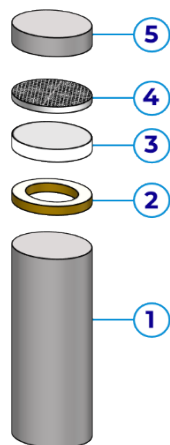

Figure 25: Refillable filter housing

- For Cleaning: Wash the filter mesh with water.
- For Replacement: Replace the filter mesh with a new one. If you do not have spare parts, please contact support@auqvian.se.
- Place the filter mesh back in the housing and screw the filter holder.

3.1.3.4.b. Zeolite Filter (ZF) and Mineralization Filter (MF)

- Unscrew the filter head counterclockwise.
- Extract the refillable filter and open it.
 - For Cleaning: Clean the filter with deionized water.
 - For Refill: After cleaning you must refill the filter if the flow is low.
 - Replacement: Once a year. If you do not have spare parts, please contact support@auqvian.se.
- Install the refillable filter, make sure to follow this order:



| Number | Description |
|--------|-----------------|
| 1 | Filter body |
| 2 | Plastic O-ring |
| 3 | Sponge |
| 4 | Protection grid |
| 5 | Filter cap |

Figure 26: Refillable filter

- Place the filter in the housing and screw the filter head clockwise.

3.1.3.4.c. Sediment, Mineralization, Ultrafiltration and Activated Carbon Filters

- Unscrew the filters counterclockwise.



Figure 27: Filters extraction

- Replace the filters with new ones and screw them.
- If you do not have spare parts, please contact support@auqvian.se.



Please check Possible Anomalies in the ***Troubleshooting*** chapter.

Frequency:

Wound Propylene Sediment Filter:

Cleaning: Between 3 months. In dusty environments, the cleaning frequency may increase.

Replacement: Once a year.

Zeolite Filter and Mineralization Filter:

Refill: Around 6 months, refill frequency varies as a function of water consumption.

Replacement: Once a year.

Sediment, Ultrafiltration and Activated Carbon Filter:

Replacement: Once a year, replacement frequency varies as a function of water consumption.

3.1.3.6. Replacement of the UV lamp

- Extract the UV Lamp body from the holder and unscrew the Quartz sleeve lock nut.

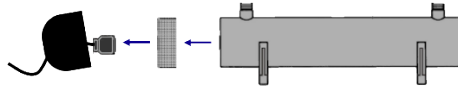

Figure 28: UV Lamp body breakdown

- Make sure that the sealing O-ring is installed in the quartz sleeve. Introduce the quartz sleeve into the UV Lamp body.

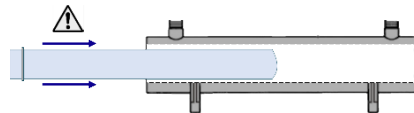

Figure 29: Quartz sleeve installation

- Screw the lock nut, connect the UV Lamp and insert the lamp into the quartz sleeve

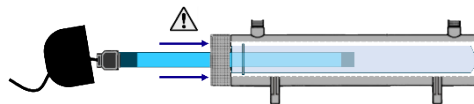

Figure 30: UV lamp installation

If the replacement of the lamp body and / or the brass connections was necessary, please follow these instructions:

- Disconnect the UV Lamp body from the Hydraulic circuit by disconnecting the quick connection.
- Remove the UV Lamp body from the brass connections by unscrew them.
- Screw the new brass 3/8"-female connections (in case they were deteriorated) to the water inlet / outlet.
- To connect the lamp to hydraulic circuit it is necessary to install a 3/8"–10mm quick connection to each brass connection.

Note: In any screwed hydraulic connection, it is especially important to coat the connections with Teflon to ensure the tightness. Please, make sure that these connections are properly tightness to avoid leaks.

Frequency:

- **Cleaning of the Quartz sleeve:** Once a year.
 - **Replacement of Quartz sleeve and the UV lamp:** Around two years.
-

3.1.3.7. Water Tank Cleaning

With the use of the generator, the water tank will accumulate sediments. It is important to keep it clean and inspected periodically. To perform a correct maintenance, follow these steps:

- Turn off the generator by pressing the ON/OFF key and disconnect the generator from the grid.
- Remove the hydraulic circuit access panel.



Figure 31: Hydraulic circuit access panel

- Disconnect the level buoys connector, unscrew and pulling the two parts in opposite directions.



Figure 32: Level buoys connector

- Disconnect the inlet and the suction pipe from the tank.
- Remove the allen screw that tighten the water tank
- Remove the cover. Clean the tank with a damp cloth. Do not use solvents, degreasers or products harmful to people.
- Once relocated all the elements, turn on the generator.

Frequency: Depending on the air quality of the place, its frequency is 1 month

3.1.3.8. Chlorine Deposit Recharging (with Chlorine Dosing Optional)

The chlorine deposit must be recharged to ensure chlorination by following these steps:

- Open the generator.
- Check the chlorine level visually. Additionally, in case the tank remains empty, the screen of the dosing pump will show a red light in alarm signal.
- If the chlorine level is insufficient, fill with the authorized refill (Sodium Hypochlorite suitable for human consumption) to achieve a concentration of 0.75ppm (mg / l).
 - Use a product which concentration is 40 grams of chlorine per liter (3.7% active chlorine).
 - In case of using a product with a different chlorine concentration, dilute to achieve the concentration of 40 grams of chlorine per liter (3.7% active chlorine).
 - For example: In the case of a product which concentration is 15000 grams of chlorine per liter (12.38% active chlorine), make a mixture of sodium hypochlorite and water in the chlorine tank, following the proportion of 1 part of Hypochlorite for every 3 parts of water.
- Close the generator side cover.



In case of using a Sodium Hypochlorite of a different concentration, it is necessary to modify the solution of the chlorine tank following the proportion described in this manual.

Frequency: Around 1 month.

3.1.4. Preservation During Long Periods of Inactivity

It is **IMPORTANT** to carry out the correct hygiene of the generator if it is going to be more than a week out of operation, as the pipes and filters can be contaminated due to the lack of use. Despite the warranty offered by the generators regarding their hygiene, the pipes' sections between the tank and the dispensing tap can contain microbiological contamination if the generator is not operating.

The manufacturer will not be responsible for any defect, in this sense, if the following procedure is not followed to avoid such contamination:

- Always perform a hyperchlorination of the generator's hydraulic circuit when it has been in a period of inactivity of more than a week.
For this we will aim for a total chlorine concentration of 7mg/l to eliminate any possible pathogens that may have been developing during the period of inactivity. The table below shows the volume (ml) of sodium hypochlorite to be used depending on the richness of the sodium hypochlorite used.

The total volume of water to be treated corresponds to 12 liters, the capacity of the internal tank.

Table 4: Hyperchlorination

| Water amount | Product Concentration | Chlorine |
|-----------------------|-----------------------|----------|
| 12 liters (full tank) | 1% | 8.4 ml |
| 12 liters (full tank) | 2% | 4.2 ml |
| 12 liters (full tank) | 3% | 2.8 ml |
| 12 liters (full tank) | 4% | 2.1 ml |
| 12 liters (full tank) | 5% | 1.7 ml |
| 12 liters (full tank) | 6% | 1.4 ml |
| 12 liters (full tank) | 7% | 1.2 ml |
| 12 liters (full tank) | 8% | 1.05 ml |
| 12 liters (full tank) | 9% | 0.93 ml |
| 12 liters (full tank) | 10% | 0.84 ml |

- In case the richness of your sodium hypochlorite is different from the one shown in the table above, you can make the calculation using the following equation:

$$V_{NaClO} \text{ (ml)} = \frac{V_{water} \text{ (l)} \times C_{final} \text{ (mg/l)}}{Richness \text{ (mg/ml)} \times 10}$$

V_{NaClO} = Volume of hypochlorite

V_{water} = Volume of water in the tank

C_{final} = Concentration desired of hypochlorite (7 mg/l is the advisable value for hyperchlorination)

$Richness$ = % of hypochlorite richness (data available in material safety datasheet)

- After more than one month without use, after the hyperchlorination and empty the tank twice through the service. It is advisable to carry out a tap water analysis according to the local regulation, to detect anomalies in the water treatment, in this case, it is necessary replace it. Check at least the following parameters:
 - Coliform bacteria (E. coli)
 - Aerobia bacteria
 - Ammonia
 - pH
 - Nitrites



For long periods of inactivity, it is advisable to empty the tank, the filters, the UV and empty the pipe (to do this, disconnect the pipe from solenoids valves and the pipe sections before and after the filters).

3.2. Professional Maintenance

The **Professional Maintenance** includes all the tasks of the **Basic Maintenance** plus those described in this section which must be carried out by a refrigeration specialized and authorized technician.



Any repair, replacement or intervention on the generator of unauthorized personnel will lead to the cancellation of the warranty.



During maintenance, turn off the power and wear protective gloves and goggles to protect against cuts and splashes.

Frequency: Annual and in case of any anomaly detected.

Professional Maintenance includes the following tasks:

- The generator metallic parts corrosion control (chassis, bodywork, exchangers, electrical panel, etc).
- Check the air, water and refrigerant isolation circuits.
- In case of an incident, the repair of mechanical parts, refrigeration elements and hydraulic circuit.
- Check the electrical connections.
- In case of an incident, replacement or repair of electrical generator elements.
- Handling of protection elements, control panel, start-up, stop and emergency switches.

In addition to the maintenance tasks recommended above, the generator will be affected by the applicable regulations in this matter.

3.2.1. Refrigeration Circuit

GENAQ Nimbus N500 is designed to work with R134A refrigerant. The use of any other refrigerant in this generator is not allowed and invalidates the warranty.

The refrigerant charging and draining will always be done in liquid phase through the Schrader valve located in the liquid line of the generator.

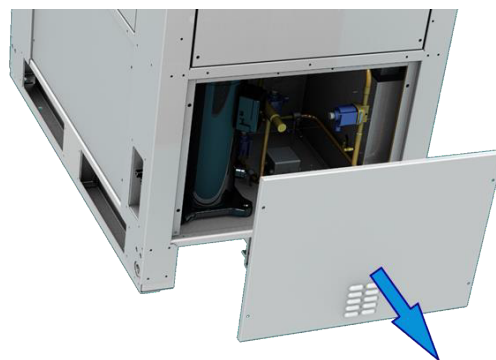

Figure 33: Refrigeration circuit

3.2.1.1. Refrigerant Charge and Emptying

Any operation related to loads, drains or replacements of the refrigerant must be carried out by authorized refrigeration professional and never by the user of the generator. The recovery of the refrigerant is mandatory for its subsequent reuse and / or disposal and must be handed over to an authorized waste manager when appropriate.

3.2.1.2. Dehydrator Filter

The filter function is to keep clean and free of moisture the refrigerant circuit neutralizing the acids that can be found therein. Check through the viewfinder indicator of the absence of liquid moisture in the system.

3.2.1.3. Oil

Look through the oil viewfinder in order to check the oil level. If there is change of color, check the quality of the oil through a contamination test. In the presence of acid, water or metallic particles, replace the affected oil circuit and the dehydrator filter. If it is necessary to replace the oil, you should use new oil identical to the original one. Both oil type and volume required for each model are listed in tables technical characteristics.

3.2.2. **Air Circuit**

If a repair or replacement of the fan is necessary, its access is done by opening the upper plate, as shown in the figure:



Figure 34: Fan access

3.2.3. Chlorine Dosing Pump

The chlorine dosing pump is programmed in *Weekly timed dosage* to ensure the water chlorination generation.



Figure 35: Chlorine dosing pump

3.2.4. Control and Electrical Circuit

This generator uses DIXELL IPG208D-10021 and VTIPG, that have been designed to control all functions of this generator.



Figure 36: Control

The control includes a small screen that allows the user to display temperatures, compressor operation and fan. It also allows to monitor and change some control parameters.

The control includes a friendly interface that allows to visualize the temperatures, alarms, and the operation of the compressor and the fan. It also allows you to monitor and change some parameters of the control.

The electrical panel, which is accessed through the generator front door, is composed of electrical safety elements and timer. If an intervention is required, please contact support@auqvian.se.

4. Troubleshooting

4.1. Troubleshooting

If there is a problem with the generator, check the table below and follow these tips. In case you might need additional assistance, please contact support@auqvian.se.

Table 5: Troubleshooting tips

| Symptom | Cause | Solution |
|--|---|---|
| The generator does not turn on | a) Absence of electrical power | a) Check differential, MCB |
| The compressor does not start The compressor pilot is on | a) Absence of electrical power b) Burned contactor coil c) Internal Klixon open d) Inlet Temp lower than set point | a) Check differential, fuses b) Change it c) Wait for rearming, check intensity absorbed |
| The compressor does not start The compressor pilot flashes | a) The contacts of a control element are open (pressure switches) b) Anti-short cycle timing does not allow start-up | a) Check the safety chain in electronic regulation b) Wait and verify electronic regulation c) Check the continuity of the contact (jumper connection) |
| The compressor stops a few seconds after starting, the engine sounds intermittently, and opens the internal Klixon | a) Very low network voltage b) Damaged starter kit (check starter relay opening) c) Crammed compressor d) Crashed compressor | a) Check the voltage of the line and locate the voltage drop b) Replace compressor and starter kit c) Check the oil level, and return the oil to the compressor through the suction pipe. If it is necessary to install siphons and resize the pipe. d) Replace the compressor |
| Repeated stops and starts of the compressor | a) The compressor light flashes b) The compressor pilot remains on. (cut by Klixon) c) Regulating differential too low | a) Check pressures and / or check the safety chain (pressure switches) to find the cause High- or Low-pressure switch cut-out b) Increase the temperature or humidity differential |
| High pressure switch cut PAL Alarm: Very high condensation pressure | a) Insufficient flow or recirculation of air b) Dirty or clogged air filter c) Fan is damaged d) Dirty or clogged condenser e) High ambient temperature | a) Check air circuits (flow, recirculation, obstructed air outlet) b) Clean c) Repair d) Clean |
| Evaporator blocked by ice PAL Alarm: Very low evaporation pressure (low pressure switch cut) | a) No evaporator flows b) Cooling fan breakdown c) Continuously frozen Evaporator d) Filter clogging liquid (having different temperature at the inlet and outlet) e) Lack of gas f) Very low-pressure condensation g) Low room temperature | a) Clear air intakes b) Fix it c) Check defrost, defrost parameters change. d) Changing the filter e) Find leak, complete loading f) Air temperature at very low condenser (very high air flow), adjust control parameters condensation or relocating generator |
| The compressor is noisy | a) Loose Fixation b) Lack of oil c) Default compressor | a) Set b) Add oil up to recommended level c) Change it |
| Defrosting is not performed | a) Power failure b) Probe out of evaporator coil c) Non-operating module Defrost | a) Check contactor and fuse b) Check reading in Pb2 probe / check location c) Check defrost parameters |
| EAL Alarm | a) Plate unconfigured to default | a) Check the plate configuration |
| Null / Sparse production | a) Clogged filters b) Membrane saturated | a) Replace filters b) Replace membrane |
| Plastic or synthetic flavor | a) Start-up or non-use b) Spent mineralization filter | a) Water filling and complete emptying of the water tank twice b) Replace the mineralization filter |
| Chlorine taste and smell (with the option chlorine dosing) | a) Spent activated carbon filter | a) Replace activated carbon filter |
| Unpleasant taste and smell | a) Environmental pollution | a) Replace the filters, the membrane and sanitize the circuit |



AUQVIAN
GENAQ Authorized Partner



Auqvian AB

Birger Jarlsgatan 41A
111 45, Stockholm Sweden

+46 8 80 11 30

www.auqvian.se

support@auqvian.se

